

ME Engines – the New Generation of Diesel Engines

INTRODUCTION

The introduction of the electronically controlled camshaft-less low speed diesel engines, which is now gaining momentum, is a milestone in diesel technology that deserves a place in history like Rudolf Diesel's first engine in Augsburg, the 1912 motor vessel *Selandia*, the introduction of turbocharging on two-stroke diesels in 1954, and the first SCR (Selective Catalytic NO_x Reduction) systems on ships in 1989.

This paper will outline how MAN B&W takes advantage of this new technology in its ME-range of engines by combining traditional, proven technologies with enhanced electronic control so as to design engines which, while being both production-friendly and operationally easy to handle, yet will provide all benefits to the owner and operator of contemporary and future software achievements. Fig. 1 shows the first such commercial ME-C engine in Frederikshavn, Denmark.

Camshaft-controlled diesel engines have been the state of the art ever since the birth of reciprocating machinery and have been refined and developed ever since. However, a mechanical cam is fixed once made and, in spite of various mechanical and hydraulic add-on devices like VIT, etc., timing control possibilities are limited with mechanical cams. Not least fuel injection pressure control and variation over the load range have limitations with a cam-controlled engine.

Therefore, the main purpose of changing to electronic control is to ensure fuel injection timing and rate, as well as the exhaust valve timing and operation, exactly when and as desired, see Fig. 2.

Especially with respect to the fuel injection rate,

the control system has been so designed that it is possible to maintain a rather high injection pressure also at low load, without the limitation from the camshaft-controlled engine, where this would result in too high pressure at high load. Both the 'cam angle, inclination and length' are electronically variable. In addition, the ME engine features electronic control of the cylinder lube oil feed, by having our proprietary Alpha Lubricators integrated in the system. With the Alpha Lubrication system, about 0.3 g/bhph cyl. oil can be saved, compared with engines with mechanical lubricators.

The electronic control of the engine fuel injection and exhaust valves improves low-load operation, engine acceleration, and give better engine balance and load control, leading to longer times between overhauls, also by implementation of enhanced diagnostics systems. It will give lower fuel consumption, lower cylinder oil consumption and, not least, better emission characteristics, particularly with regard to visible smoke and NO_x, see Fig. 3 for a summary.

For the ME engines, the electronic control system has been made complete. Hence, the ME engine features fully integrated control of all functions like the governor, start and reversing, fuel, exhaust and starting valves, as well as cylinder oil feeding, as summarised in Fig. 4.

ELEMENTS OF THE ME-C ENGINE

The mechanical difference between an MC-C engine and its electronically controlled counterpart, the ME-C engine, constitutes a number of mechanical parts made redundant and replaced by hydraulic and mechatronic parts with enhanced functions, as illustrated in Fig. 5 and summarised below:

The following parts are omitted:

- Chain drive
- Chain wheel frame
- Chain box on frame box
- Camshaft with cams
- Roller guides for fuel pumps and exhaust valves
- Fuel injection pumps
- Exhaust valve actuators
- Starting air distributor
- Governor
- Regulating shaft
- Mechanical cylinder lubricator
- Local control stand

The above-mentioned parts are replaced by:

- Hydraulic Power Supply (HPS)
- Hydraulic Cylinder Units (HCU)
- Engine Control System (ECS), controlling the following:
 - Electronically Profiled Injection (EPIC)*
 - Exhaust valve actuation*
 - Fuel oil pressure boosters*
 - Start and reversing sequences*
 - Governor function*
 - Starting air valves*
 - Auxiliary blowers*
- Crankshaft position sensing system
- Electronically controlled Alpha Lubricator
- Local Operating Panel (LOP)

Fig. 6 shows how the necessary power for fuel injection and exhaust valve operation – previously provided via the chain drive – is now provided from a Hydraulic Power Supply (HPS) unit located at the front of the engine at bedplate level. The main components of the Hydraulic Power Supply unit are the following:

- Self cleaning filter with 10-micron filter mesh
- Redundancy filter with 25-micron filter mesh
- Start up pumps:
 - High-pressure pumps with supply pressure of 175 bar
 - Low-pressure pumps for filling the exhaust valve push rod with supply pressure of 4 bar
- Engine driven axial piston pumps supplying high pressure oil to the Hydraulic Cylinder Unit with oil pressures up to 250 bar

Before engine start, the hydraulic oil pressure used in the mechanical/hydraulic system (for controlling the actuators) is generated by electrically driven start-up pumps. After start, the engine driven pump will take over the supply.

The engine driven pumps are gear or chain driven, depending on engine size. If so preferred, all pumps can also be electrically driven. The hydraulic pumps are axial piston pumps with flow controlled by the integrated control system. There are three engine driven pumps, but actually only two are needed for operation. Second-order moment compensators, where needed, can be integrated into the pump drive. Alternatively, electrically driven compensators can be used. If so preferred, the entire hydraulic oil system can be made as a separate, independent system.

Fig. 7 shows the entire hydraulic oil loop with the hydraulic power supply system and, as can be seen, the generated servo oil is fed via double-walled piping to the Hydraulic Cylinder Units of which there is one per cylinder, mounted on a common base plate on the top gallery level on the engine, as illustrated in Fig. 8 and detailed in Fig. 9. In this latter image, also the important electronic control valves, i.e. the ELFI (a proportional ELectronic Fuel Injection control valve) and the ELVA (an on-off Electronic exhaust Valve Actuator) are shown.

The Hydraulic Cylinder Unit furthermore comprises a hydraulic oil distribution block with pressure accumulators, the exhaust valve actuator, with ELVA and a fuel oil pressure booster with ELFI, raising the fuel oil supply pressure during injection from the 10-bar supply pressure to the specified load-dependent injection pressure of 600-1000 bar. Permanent high pressure with preheated fuel oil on top of the engine is thereby avoided, without losing any advantage of high-pressure injection.

Figs. 10 and 11 show the per cylinder fuel oil injection system, and Fig. 12 shows the individual components of the fuel oil pressure booster. As will appear, the fuel oil pressure booster is mechanically much more simple than the traditional fuel pump with roller, roller guide, VIT and cut-off wedges. Figs. 12 and 13 outline the media and plunger movements in respect to a signal to the ELFI from the engine control system, Fig. 14 shows the impeccable condition of the parts after about 4,000 hrs. of

operation. Now more than 10,000 hrs have been logged, and the results are still the same. There has been virtually nothing to report. The fuel oil pressure booster is less exposed to wear than a traditional fuel oil pump and, with its significantly larger sealing length (compared with the conventional Bosch-type fuel pumps), a much longer lifetime can be expected.

Fig. 15 explains in detail how the actuator for the exhaust valve responds to the electronic actuator signal from the engine control system.

Another system that benefits from mechanical simplification by being electronically rather than mechanically controlled on the ME engine is the starting air system, Fig. 16. The mechanical starting air distributor is past history.

The Alpha Lubricator system for cylinder oil feed rate control, already with more than 200 sets sold, benefits in the ME engine version by using the 200-bar servo oil pressure as driving force rather than a separate pump station used in the stand-alone systems. The ME execution, therefore, as illustrated in Fig. 17, separates the cylinder oil from the servo oil. As shown in Fig. 18 (and Fig. 7), the Alpha Lubricator is mounted on the hydraulic oil distribution block.

The ME engine control system, simplified in Fig. 19 and with more details in Fig. 20, is designed with the principle that no single failure of anything shall make the engine inoperative. Therefore, all essential computers are with a hot stand-by.

All the computers in the system, referred to as Engine Interface Control Unit, Engine Control Units, Cylinder Control Units and Auxiliary Control Units, are of exactly the same execution and can replace each other, in that they will adapt to the desired functionality of the particular location once installed, including if replaced by a spare. The computer, often referred to as a Multi-Purpose Controller, is a proprietary in-house development of MAN B&W Diesel. Thus, we can ensure spare part deliveries over the engine's lifetime. The Local Operating Panel, incl. Cylinder Control and Auxiliary Control Units, see Fig. 21, is mounted on the middle gallery of the 7S50ME-C made in Denmark. The Control Units can, of course, also be located elsewhere.

As to installation aspects, Fig. 22 illustrates that, apart from the cabling of the control network, an ME-C engine and an MC-C engine are practically the same for a shipyard, as detailed below:

- Overhaul height: same
- Engine seating: same
- Engine outline: modifications with no influence for yard
- Engine weight: slightly reduced
- Engine pipe connection: back flush from filter on engine added, other connections are unchanged
- Gallery outline: slight modifications
- Top bracing exhaust side: same
- Capacity of auxiliary machinery: same
- Lubricating oil system: slightly modified
- Specification and installation of governor omitted
- Other systems: same
- Cabling: cables added for communication and network

Actually, there is a small simplification, as illustrated in Fig. 23, in that the tooling for the exhaust valve system and fuel oil pressure booster system is simpler.

FEATURES OF THE ME-C ENGINE

As mentioned in the introduction, the purpose of making electronic engines is focused around the virtues related to “ensuring fuel injection and rate, as well as exhaust valve timing exactly when and as desired”.

With respect to the exhaust valve movement, this means changing the ‘cam length’, as illustrated in Fig. 24, by simply changing the point in time of activating the ELVA valve. This can be used to control the energy to the turbocharger, both during steady and transient load conditions. Smoke-free acceleration is a natural benefit apart from SFOC optimisation at any load. Fig. 25 gives an illustration of how already a ‘different cam length’ was implemented on the 7S50ME-C engine in Frederikshavn for 100% load vs. 75% load.

Thanks to the multitude of possibilities with the ELFI, the proportional valve controlling the servo oil pressure to the fuel oil pressure booster, not only the fuel oil ‘cam length’, but

also the ‘cam inclination and angle’ and even the number of activations per stroke can be varied for the fuel oil injection.

Fig. 26 illustrates different profiles demonstrated during testing of the 7S50ME-C. The double injection profile is specially tailored for a significant reduction of NO_x emissions as referred to later (see Fig. 32).

Fig. 27 shows the selected injection rate on that engine at 75% load, compared with what it would have been with a fixed cam. The resulting heat release, see Fig. 28, is the reason for selecting a more intensive injection. A better heat release mirrors a better fuel consumption, also because the p_{max} is higher, see Fig. 29. Such data could of course also be realised on a mechanical engine, but not while at the same time maintaining the ability to perform at 100% load. In the low end of the load scale, the possibility for controlling the timing and rate of injection gives the possibility to demonstrate stable running down to 10% of MCR-rpm, i.e. 13 rpm against a water brake only. This could be even more stable against a propeller eliminating the need for stop-and-go operation through channels and canals and making ME engines particularly suitable for shuttle tankers and lightering vessels, as well as for vessels with greatly varying load profile.

General performance curves for the ME-C and MC-C engines are shown in Fig. 30. The lower part load fuel consumption is achieved by raising the p_{max} over the whole load range. In order to avoid too high difference between p_{max} and p_{comp} , also this pressure is raised by timing control.

As also illustrated, the lower SFOC comes at a price in that the NO_x increases. For this reason, the first two modes to be incorporated in the control system of the ME engine, as standard, are the ‘fuel economy mode’ and the ‘low-NO_x’ mode. Fig. 31 illustrates the coagency between SFOC, NO_x, and p_{max}/P_{comp} for the two modes.

It goes without saying that an ME-C engine will comply with IMO’s NO_x cap also in the fuel economy mode.

The low-NO_x mode is intended for areas where lower than IMO NO_x limits do or will apply.

The change from one mode to the other is a matter of seconds only and, of course, is done while running, as illustrated in Fig. 32.

SUMMARY

The advantages of the ME-C range of engines are quite comprehensive, as seen below:

- Lower SFOC and better performance parameters thanks to variable electronically controlled timing of fuel injection and exhaust valves at any load
- Appropriate fuel injection pressure and rate shaping at any load
- Improved emission characteristics, with lower NO_x and smokeless operation
- Easy change of operating mode during operation
- Simplicity of mechanical system with well-proven traditional fuel injection technology familiar to any crew
- Control system with more precise timing, giving better engine balance with equalized thermal load in and between cylinders
- System comprising performance, adequate monitoring and diagnostics of engine for longer time between overhauls
- Lower rpm possible for manoeuvring
- Better acceleration, astern and crash stop performance
- Integrated Alpha Cylinder Lubricators
- Up-gradable to software development over the lifetime of the engine

It is a natural consequence of the above that many more features and operating modes are feasible with our fully integrated control system and, as such, will be retrofittable and eventually offered to owners of ME-C engines.

Against this background, we are proud to present our ME-C engine programme, as shown in Fig. 33.



Fig. 1: 7S50ME-C, MAN B&W Diesel, Denmark, February 2003

Electronically Controlled Engines



WHY?

To ensure:

- Fuel injection timing and rate
- Exhaust valve operation
- Cylinder oil feed rate

Precisely **when** and **as** desired

L/73737-6.2/0403 (3000/OG)





Fig. 2: Electronically Controlled Engines, precise control

Electronically Controlled Engines



WHY?

To improve:

- Low load operation
- SFOC & SLOC
- Engine versatility
- Emissions (NO_x, soot, smoke)
- Time Between Overhauls
- Diagnostics systems
- Etc., etc.

L73723-2.1/0403 (3000/OG)





Fig. 3: Electronically Controlled Engines, improved features

Electronically Controlled Engines



The ME engine with fully integrated control of

- Starting air valves
- Start and Reversing sequences
- Governor function
- Auxiliary blowers
- Electronically Profiled Injection Control
- Exhaust valve actuation
- Cylinder oil feed rate

L73973-5.3/0403 (2440/PCS)



Fig. 4: Electronically Controlled Engines, fully integrated control

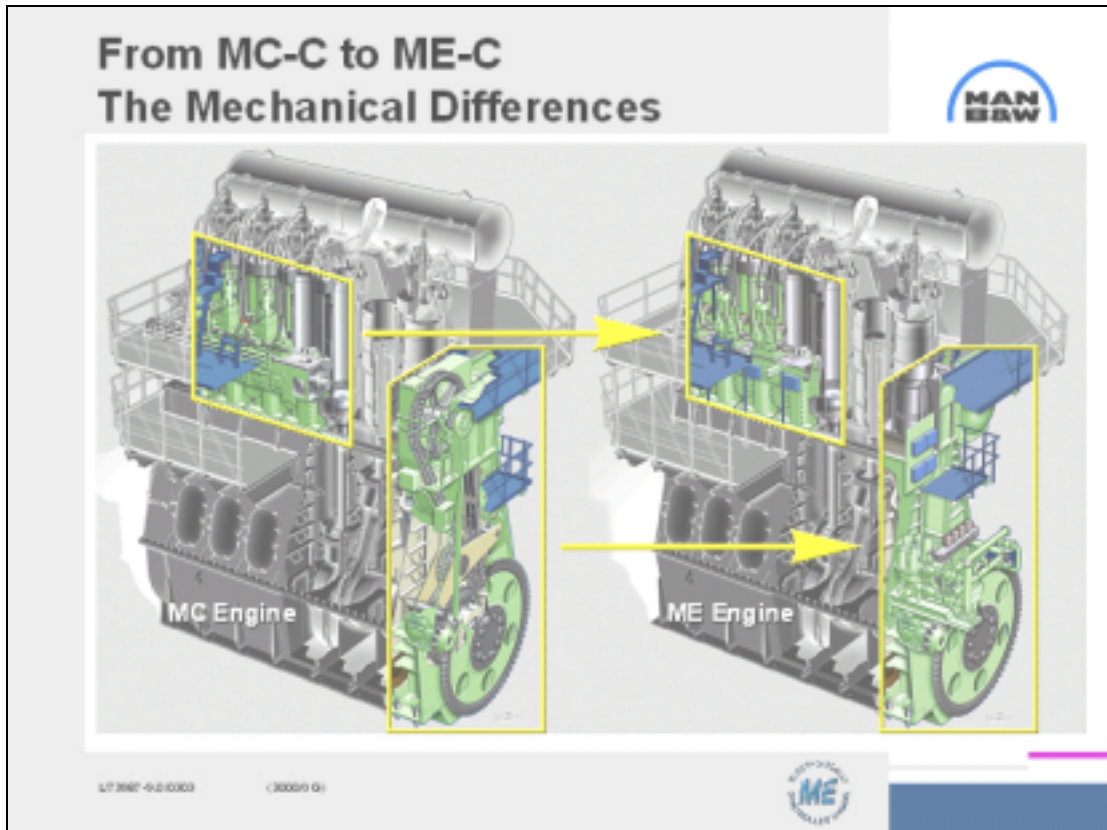

Fig. 5: From MC-C to ME-C – Mechanical Differences

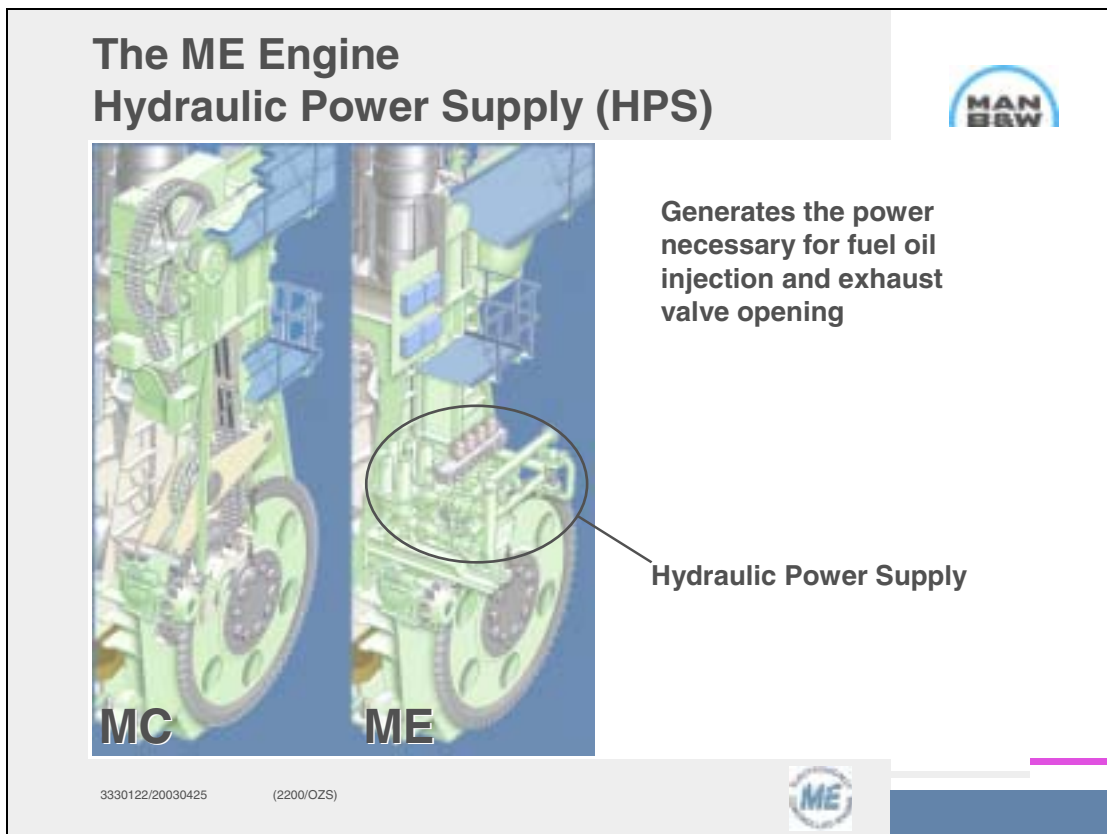

Fig. 6: Hydraulic Power Supply (HPS)

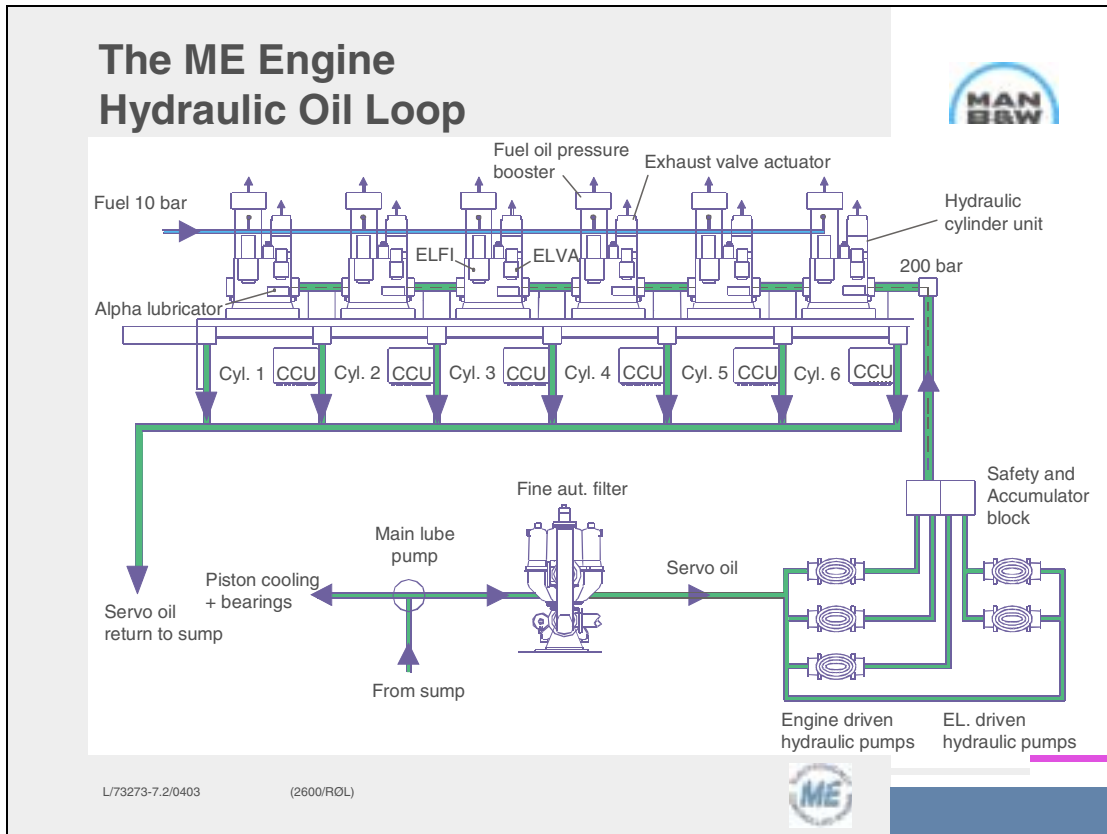

Fig. 7: ME-C Engines, Hydraulic Oil Loop

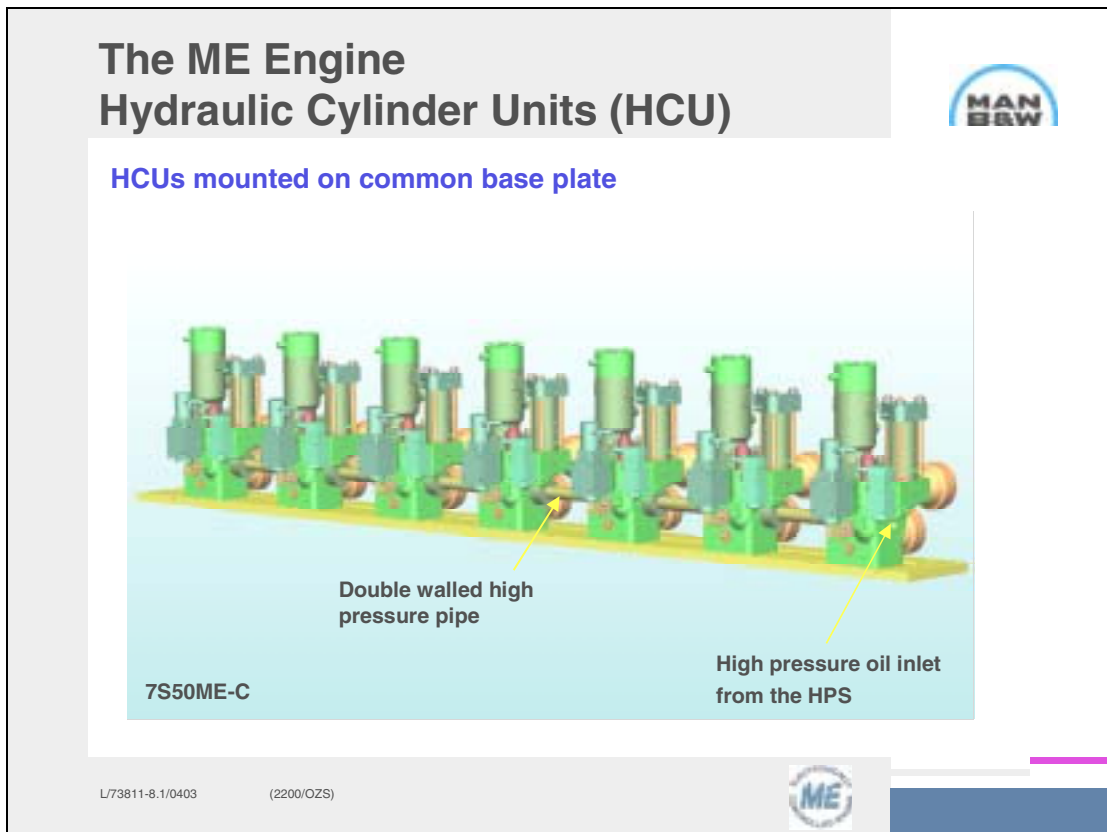

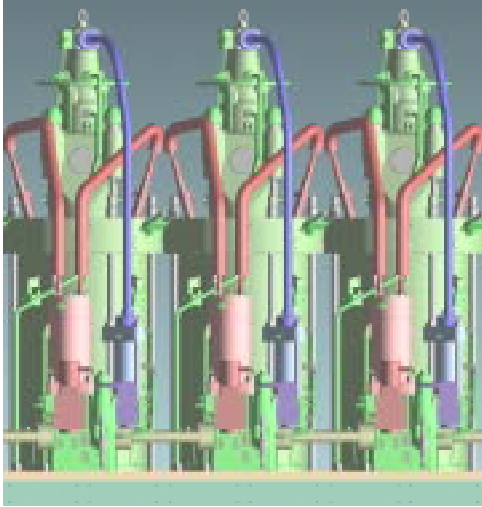
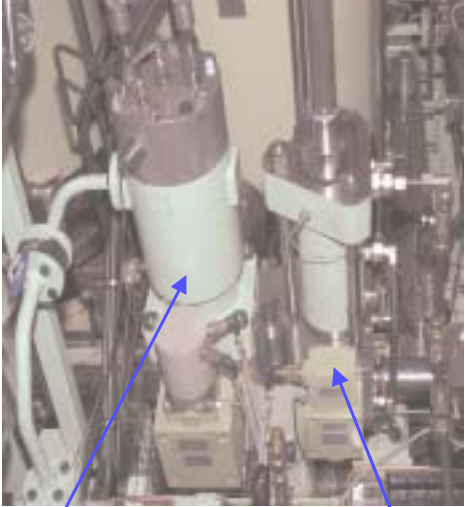

Fig. 8: Hydraulic Cylinder Units (HCU)

The ME Engine Hydraulic Cylinder Unit (HCU)



- The HCU is found on the upper gallery
- One unit in front of each cylinder

Fuel oil pressure
booster with ELFI

Exhaust valve
actuator with ELVA

3330168/20030423

(3000/OG)



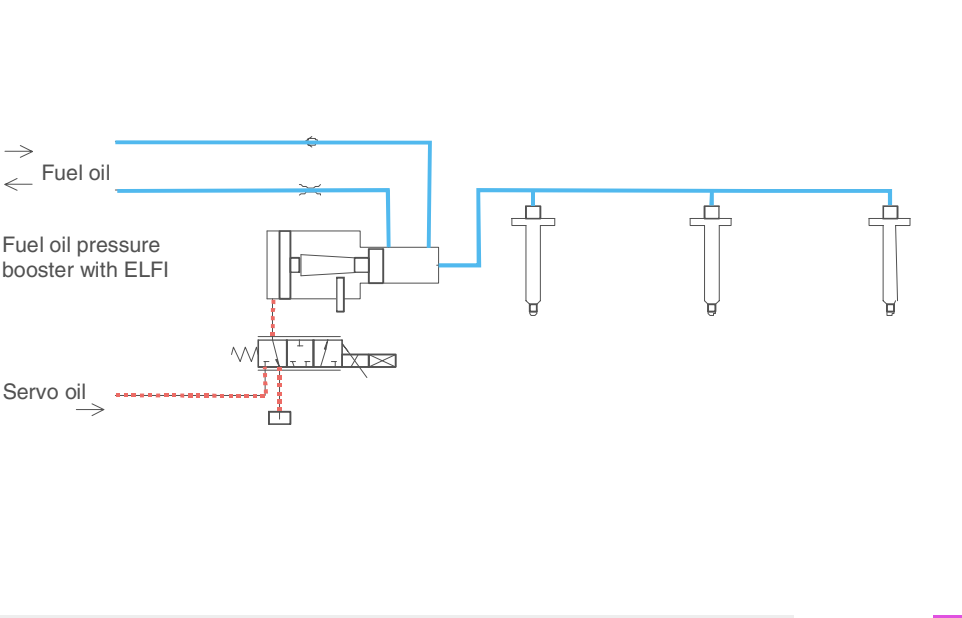

Fig. 9: Hydraulic Cylinder Unit (HCU)

The ME Engine Fuel Injection System





3330157/20030123

(3000/OG)



Fig. 10: Fuel Injection System

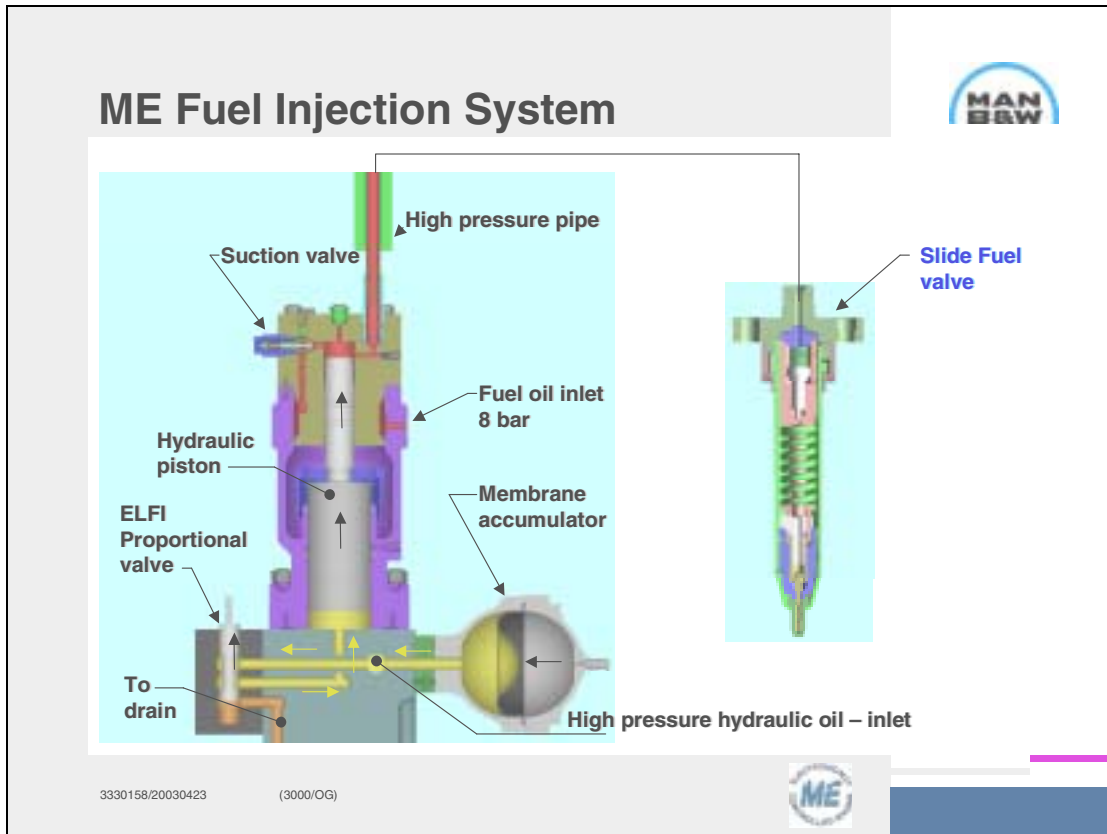

Fig. 11: Fuel Injection System

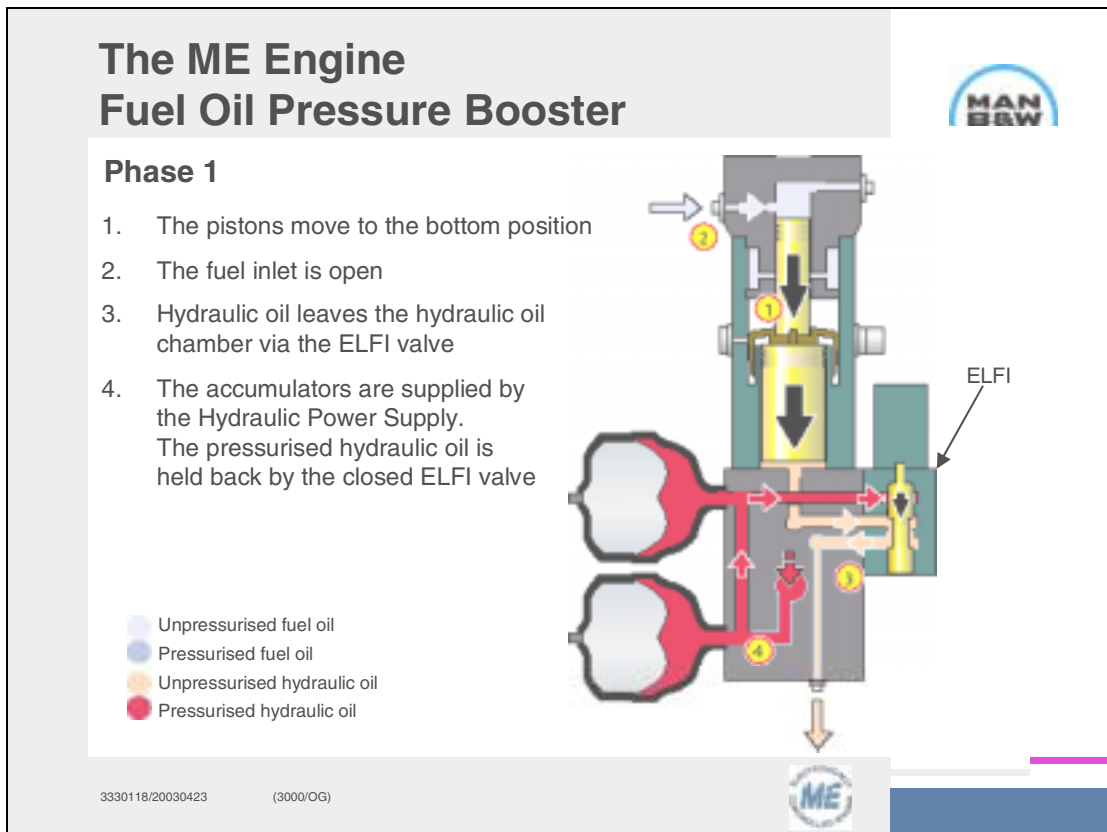

Fig. 12: Fuel Oil Pressure Booster

The ME Engine Fuel Oil Pressure Booster

Phase 2

- The ELFI valve is activated upwards, closing the return flow and opening for the flow of pressurised hydraulic oil. The oil passes through the ELFI valve and fills the hydraulic chamber
- The high pressure forces the pistons upwards
- The fuel oil inlet is closed
- The pressure on the fuel oil rises and exceeds the force of the spring in the cylinder's fuel injection valve

■ Unpressurised fuel oil
■ Pressurised fuel oil
■ Unpressurised hydraulic oil
■ Pressurised hydraulic oil

3330119/20030423 (3000/OG)

Fig. 13: Fuel Oil Pressure Booster

The ME Engine Fuel Oil Pressure Booster Actuator

■ Unpressurised fuel oil
■ Pressurised fuel oil
■ Unpressurised hydraulic oil
■ Pressurised hydraulic oil

Inspection onboard Bow Cecil after 4137 running hours as ME engine

L72591-8.1/0403 (2440 /PCS)

Fig. 14: Fuel Oil Pressure Booster Actuator

The ME Engine Exhaust Valve Actuator



The ELVA valve which drives the actuator on the exhaust side has two positions, open or closed.

When it is opened by a binary signal from the engine control system, the hydraulic oil is forced in and pushes the pistons upwards, thus opening the engine's exhaust valve via the hydraulic push rod.

The pressure is permanently maintained until the ELVA valve is activated to block the pressure when the required exhaust phase is completed.

The exhaust valve is returned to its closed position by the force from the air spring.

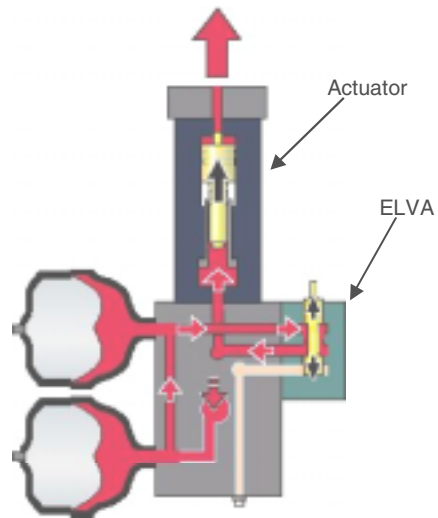

- Unpressurised hydraulic oil
- Pressurised hydraulic oil

3330145/20030414

(2200/OZS)

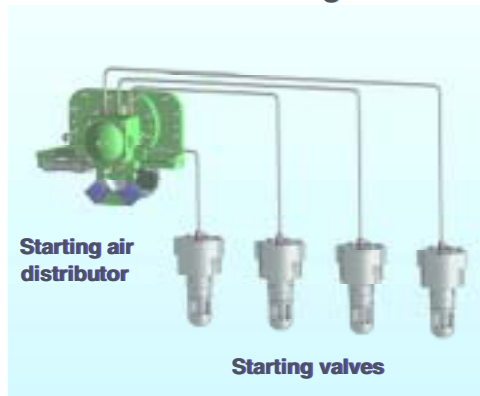

Fig. 15: Exhaust Valve Actuator

The ME Engine Starting Air System



MC-C design



ME-C design

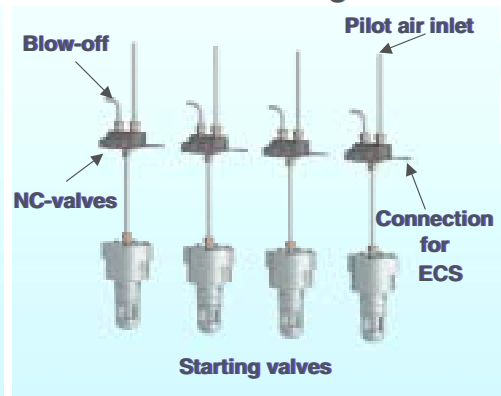

The NC valve is mounted on the main starting pipe behind the cylinder cover



L73831-0.1/0403

(2200/OZS)



Fig. 16: ME Starting Air System

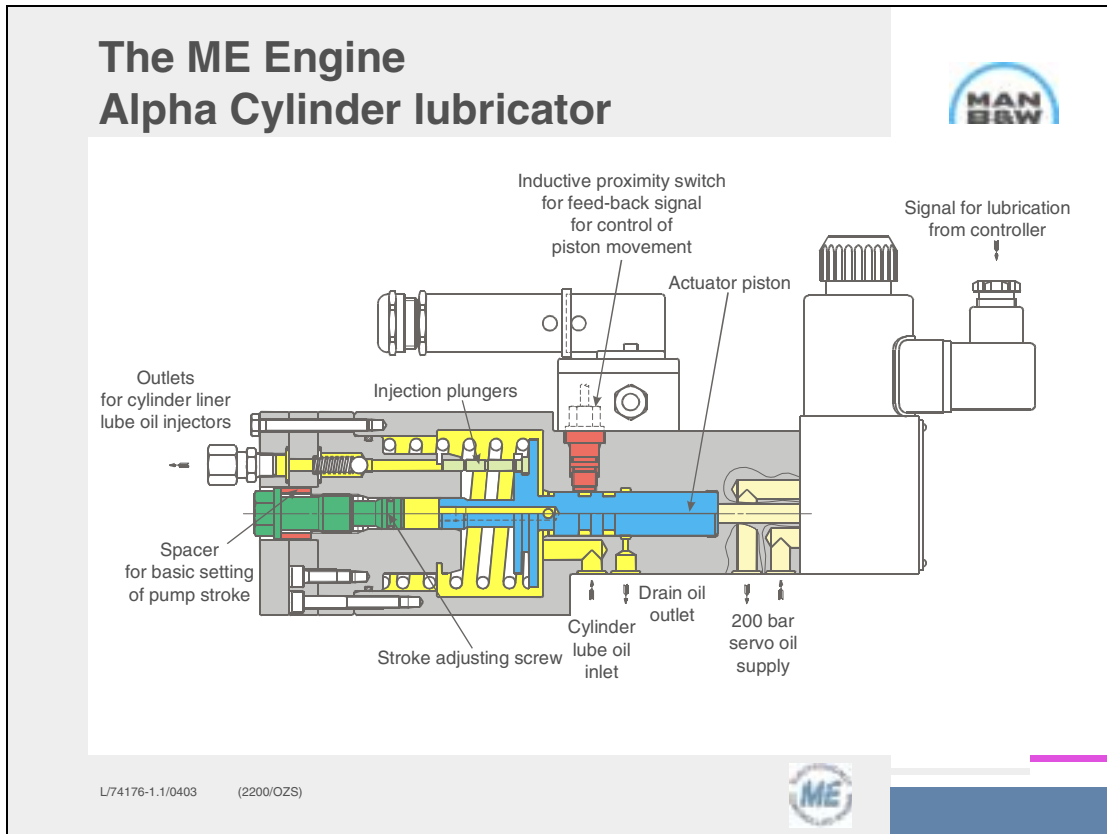

Fig. 17: Alpha Lubricator for ME Engine

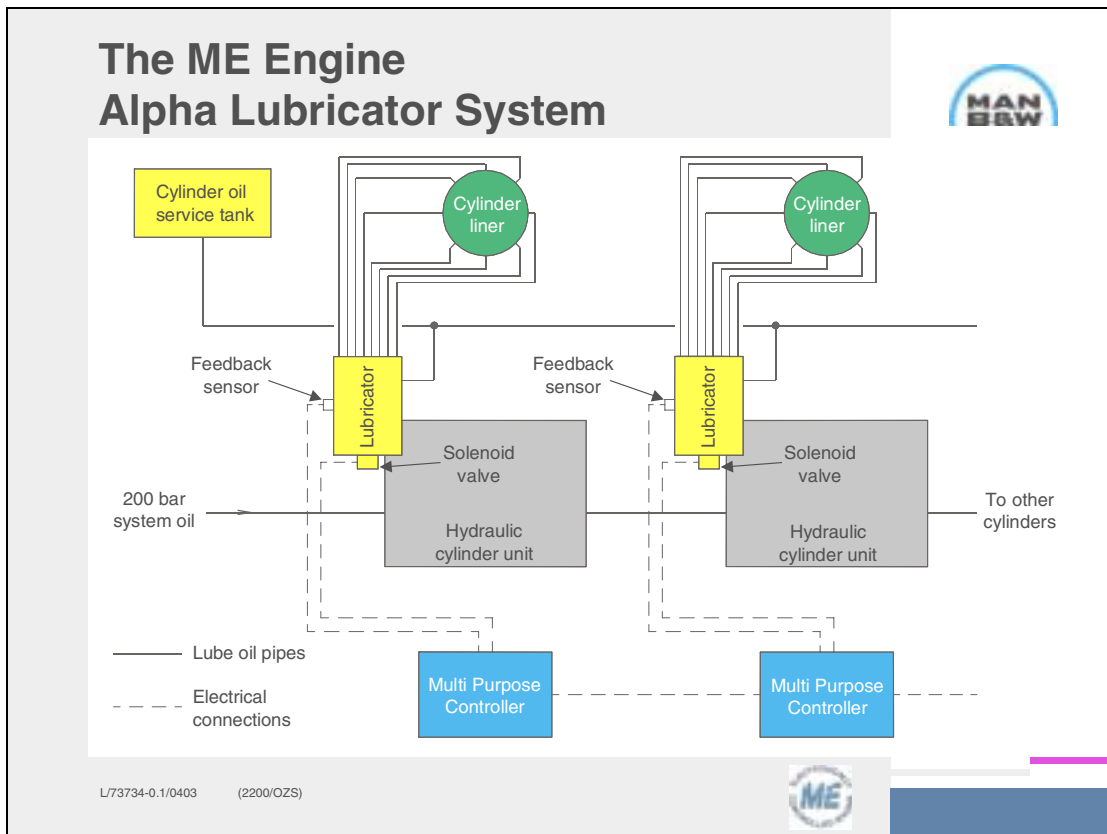

Fig. 18: Alpha Lubricator System for ME

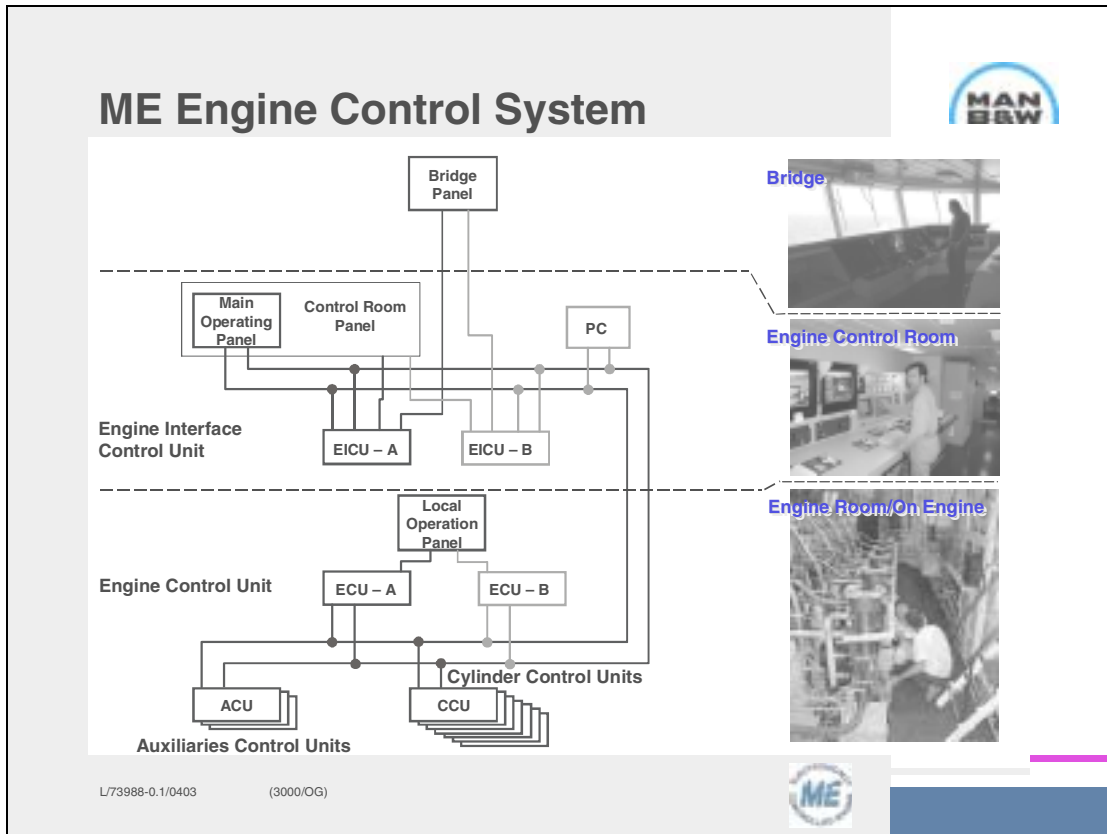

Fig. 19: ME Engine Control System

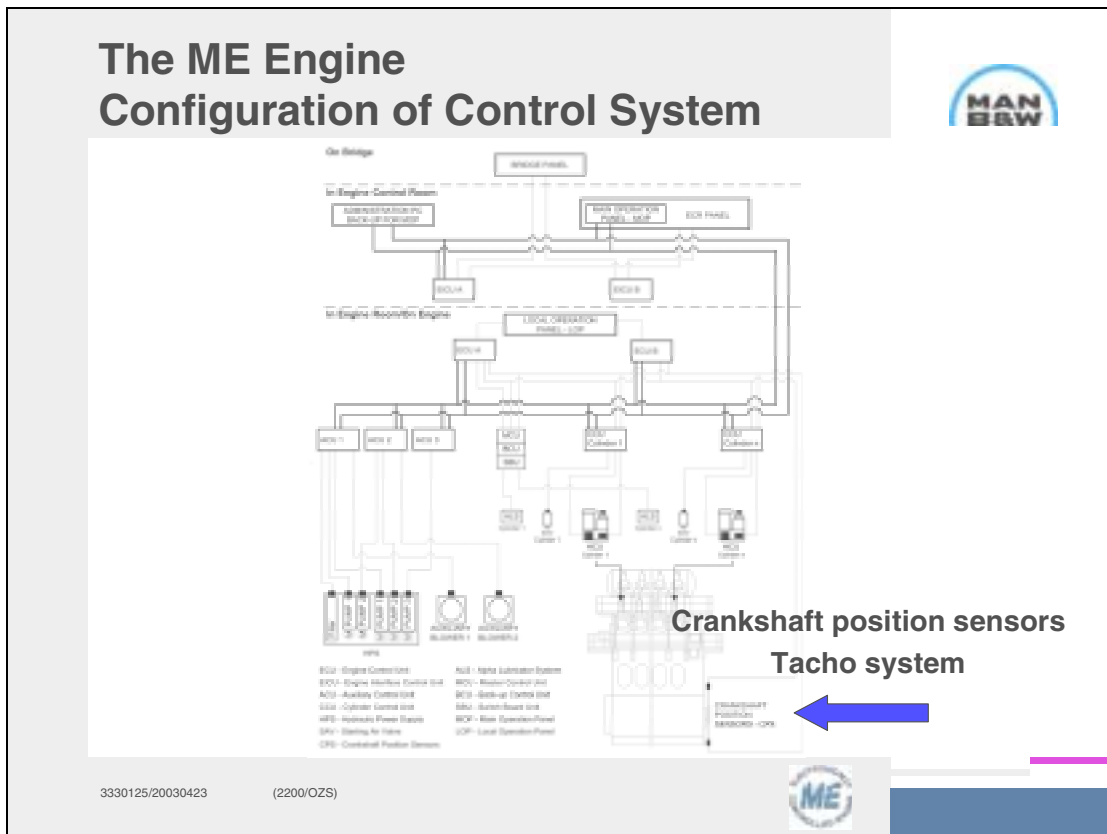

Fig. 20: Configuration of Control System

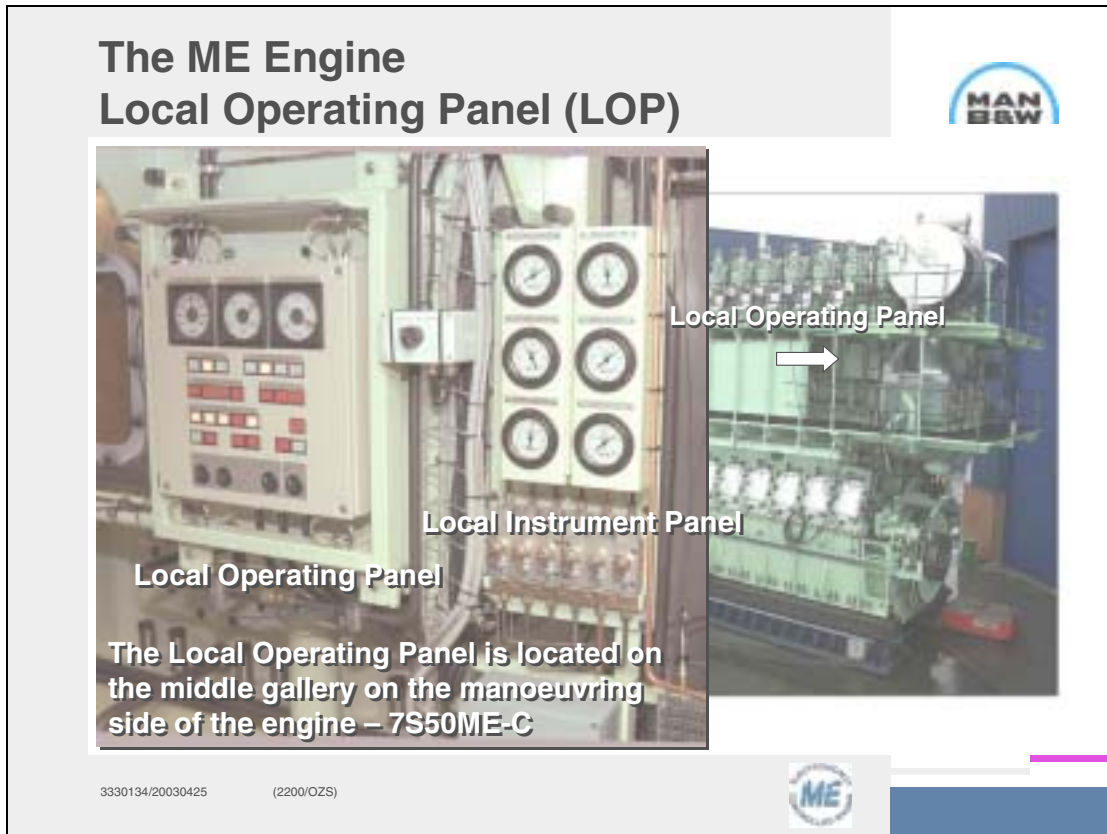

Fig. 21: Local Operating Panel (LOP)

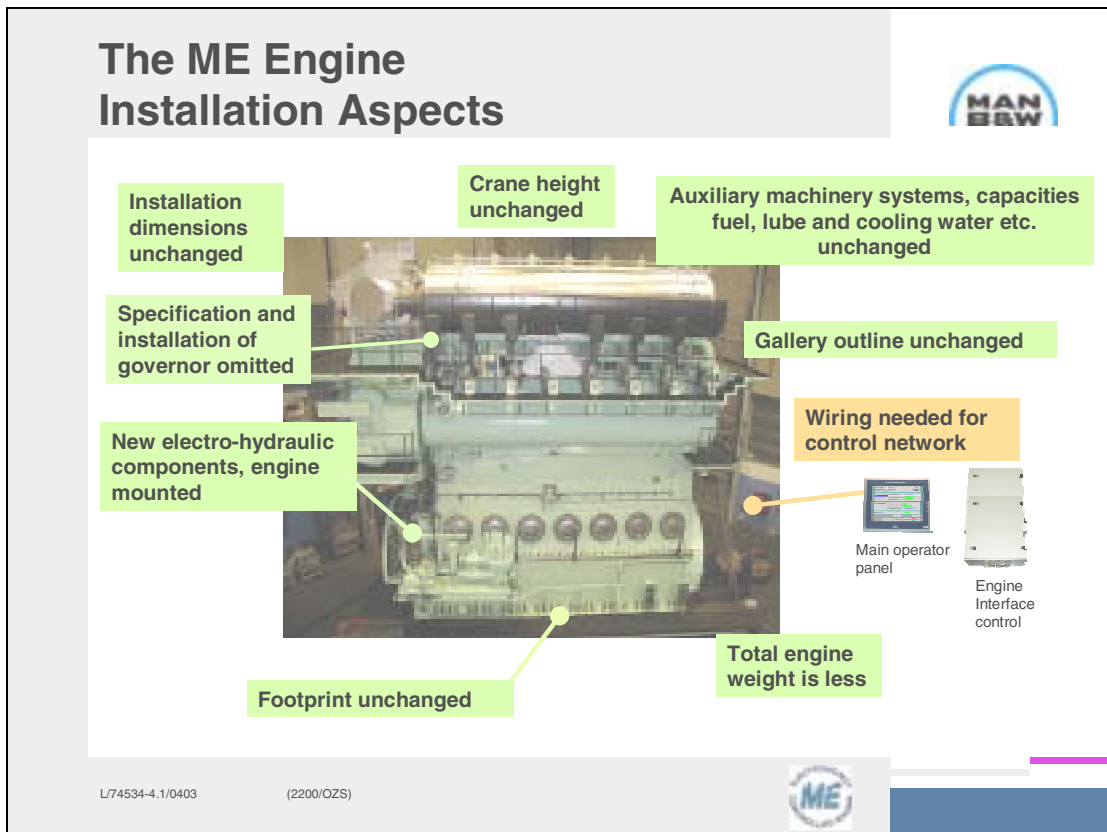



Fig. 22: Installation Aspects, ME Engine

ME - Maintenance Aspects



Simplifications compared to MC/MC-C

Fuel system:
5 tools removed and 3 added

Exhaust system:
10 tools removed and 4 added

~~**Chain drive and camshaft:**
5 tools removed~~

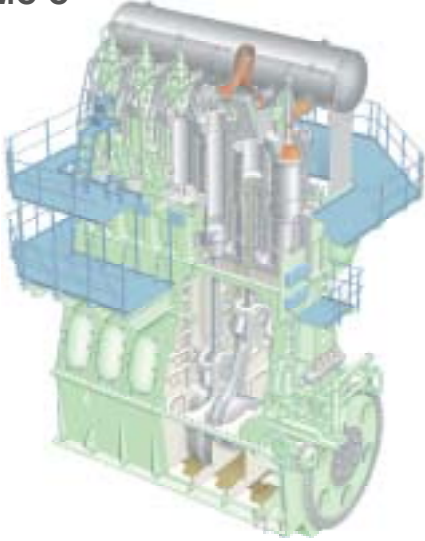

L73975-9.1/0403
2140/HMH



Fig. 23: ME – Maintenance Aspects

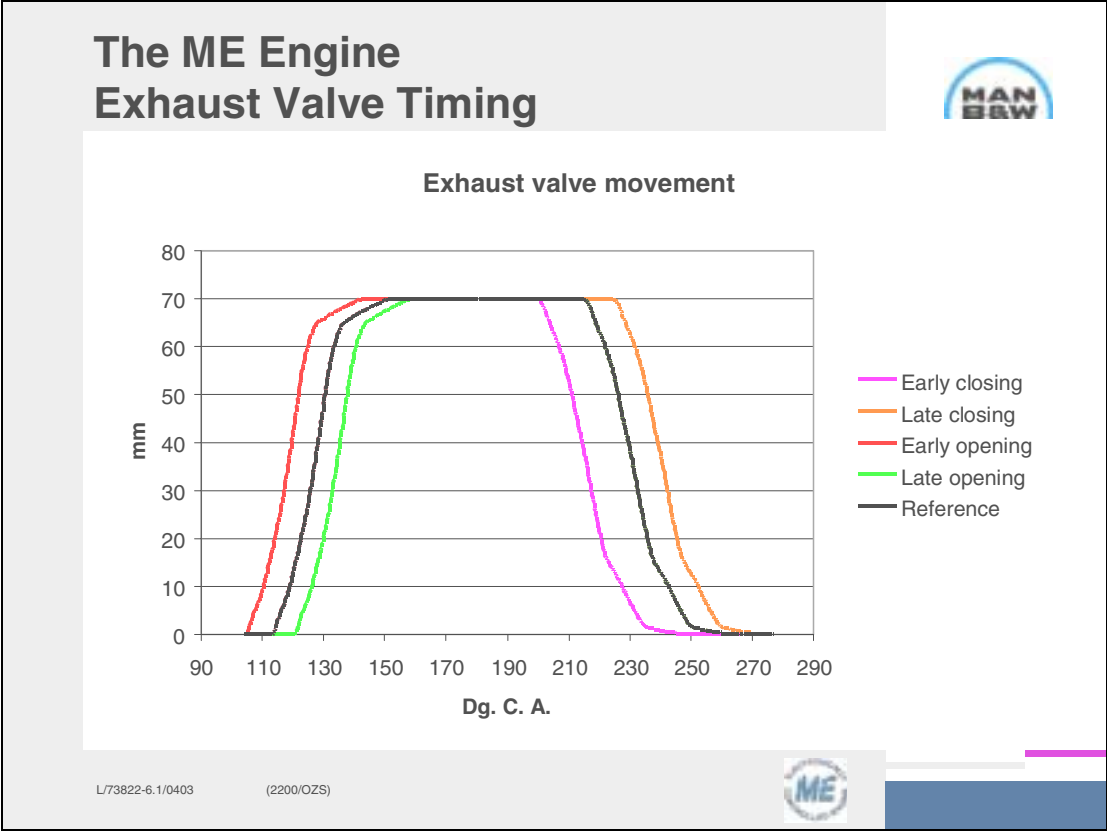

Fig. 24: Exhaust Valve Timing

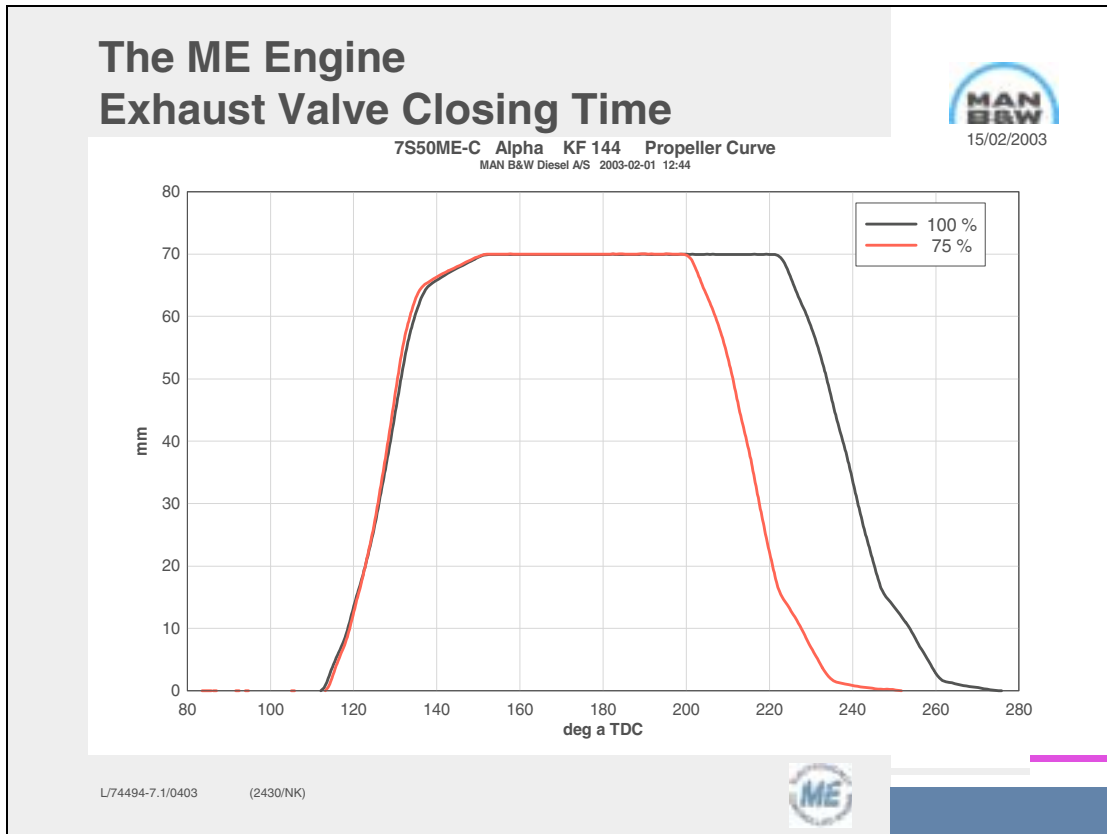

Fig. 25: Exhaust Valve Closing Time

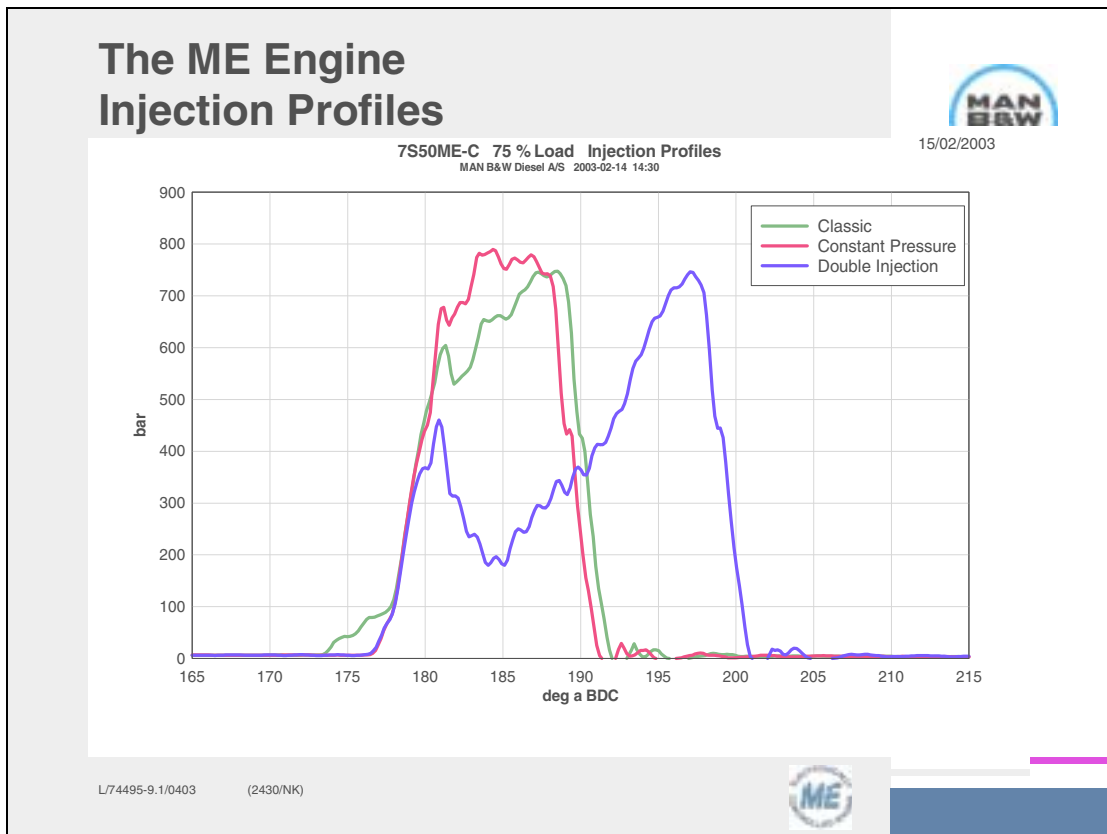

Fig. 26: Injection Profiles

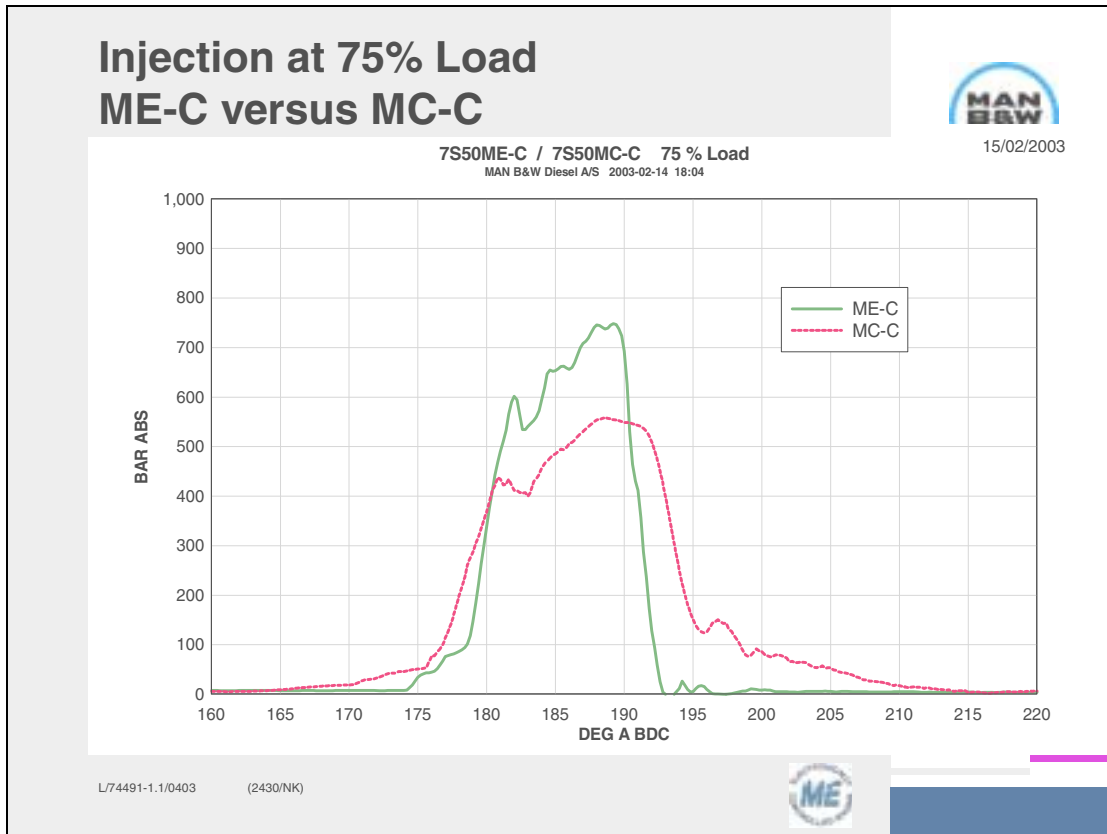

Fig. 27: Injection at 75% load, ME-C versus MC-C

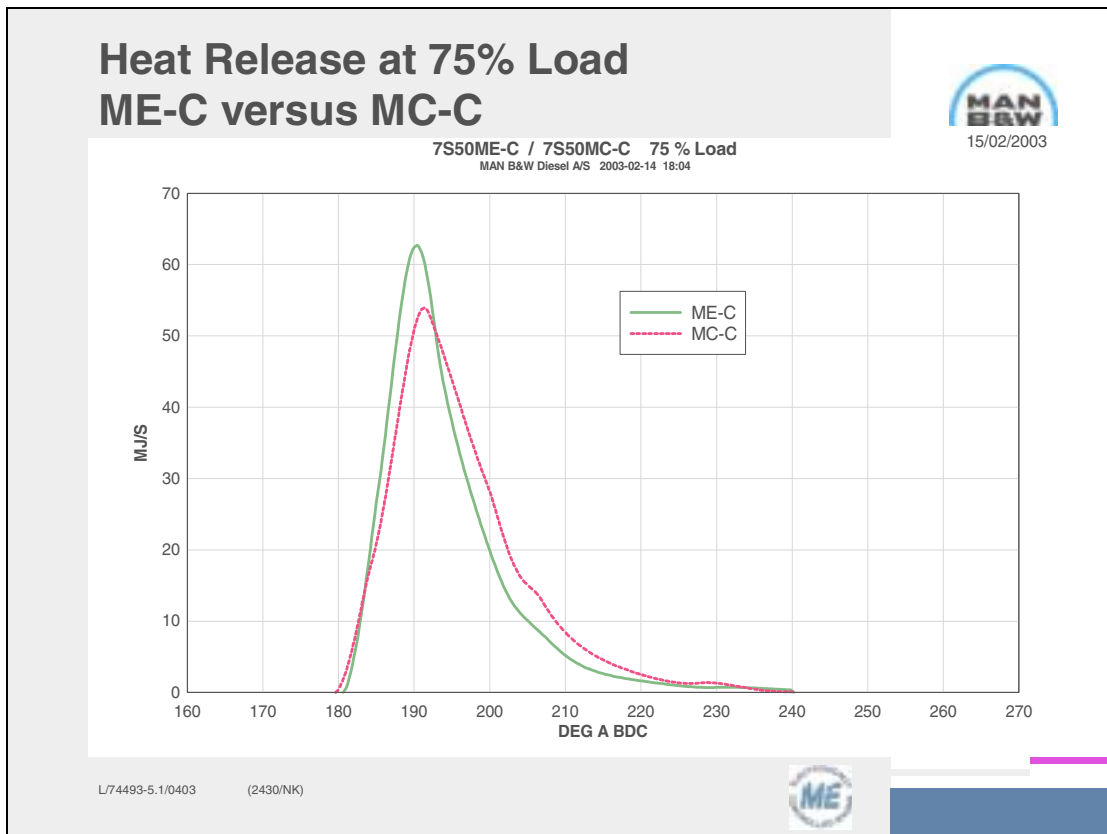

Fig. 28: Heat Release at 75% load, ME-C versus MC-C

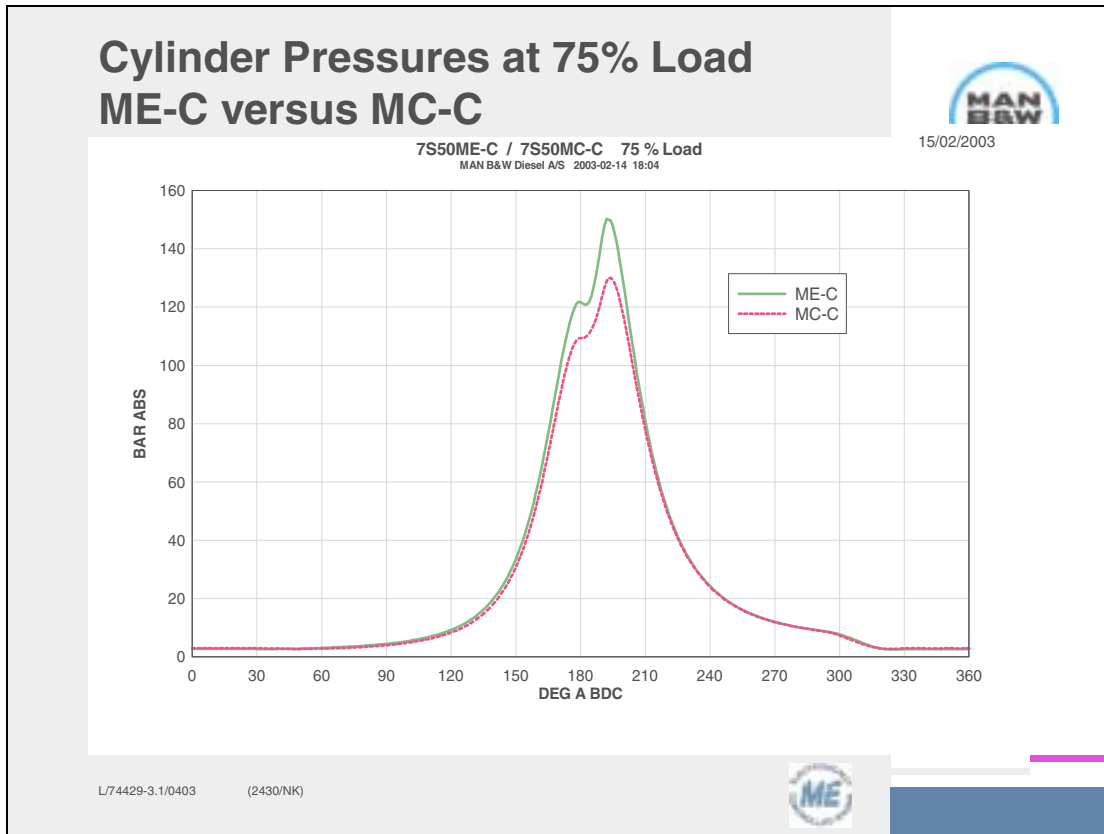

Fig. 29: Cylinder Pressures at 75% load, ME-C versus MC-C

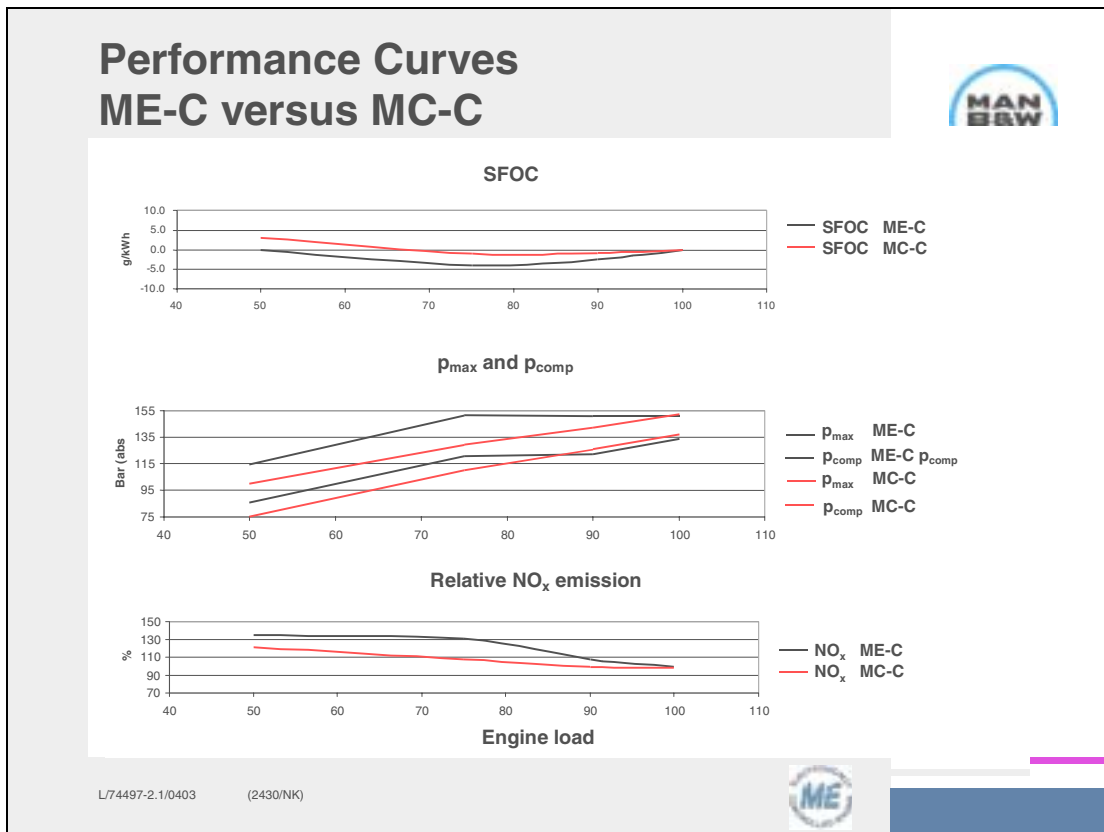

Fig. 30: Performance Curves, ME-C versus MC-C

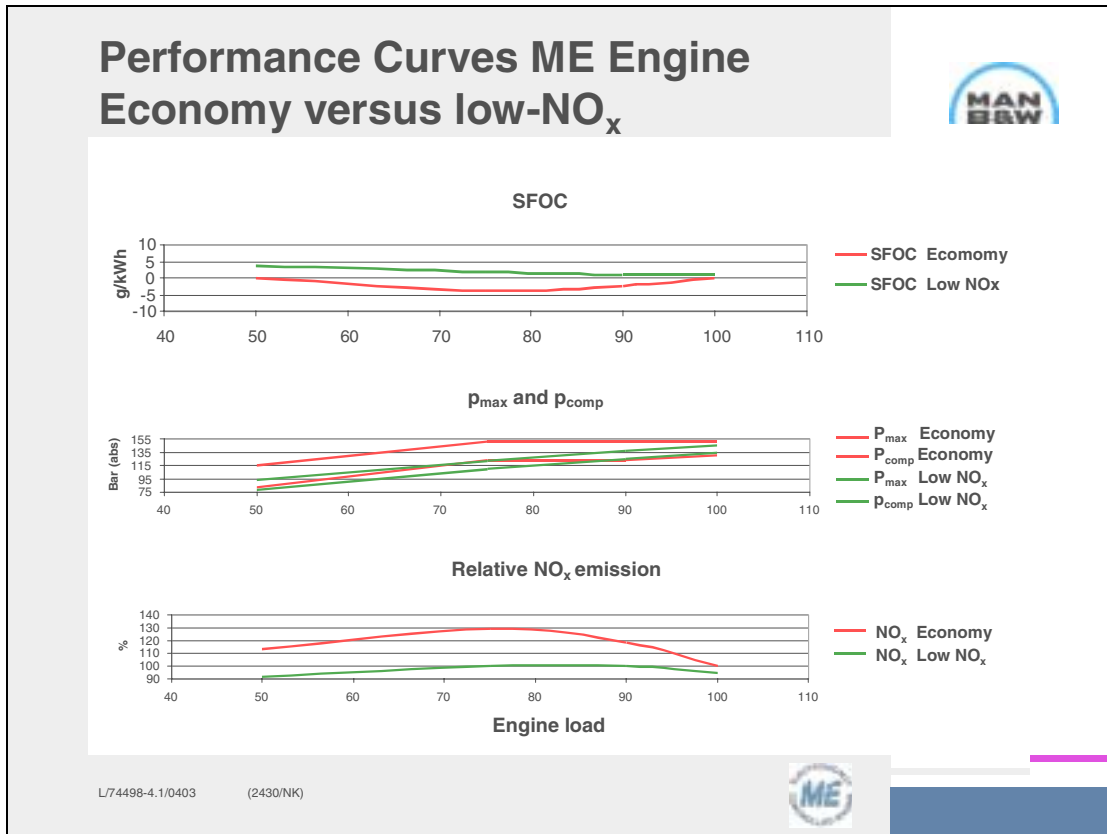

Fig. 31: Performance Curves, Economy versus low-NO_x

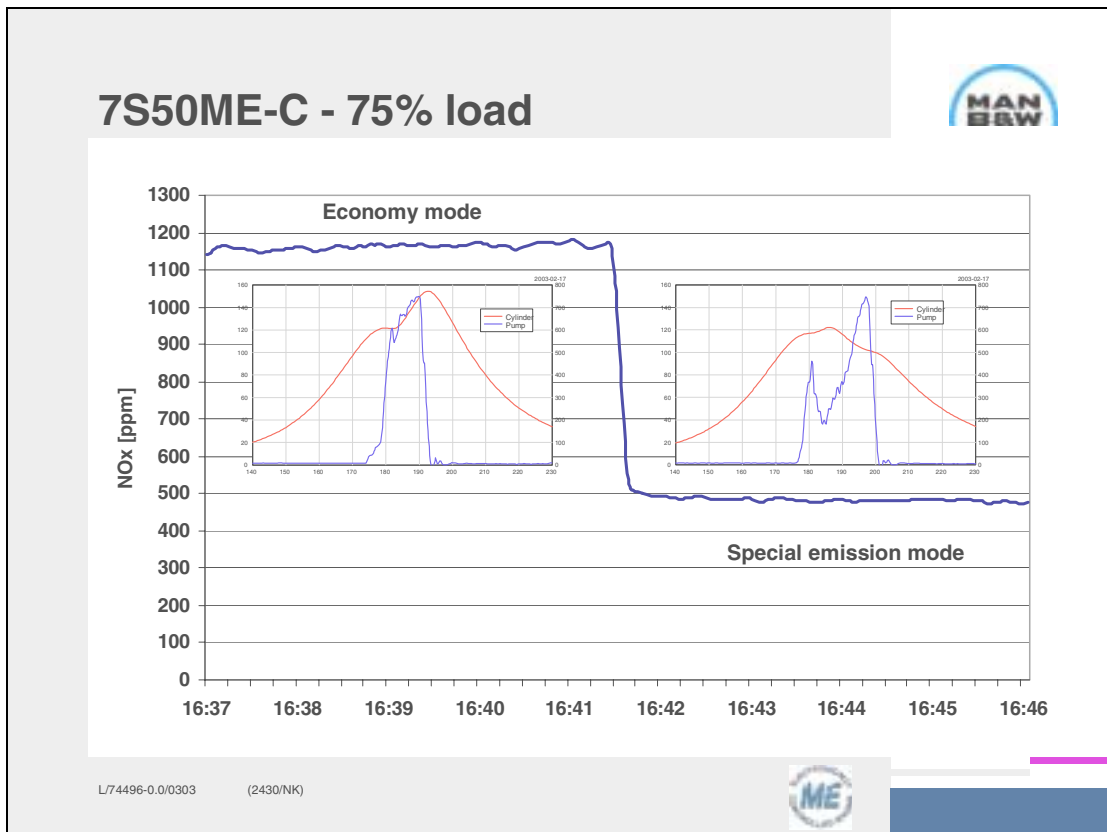
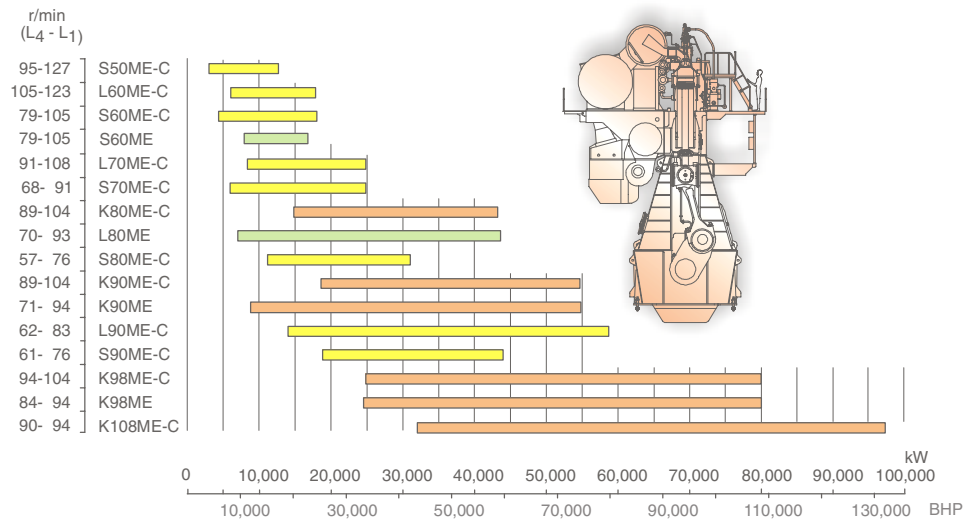

Fig. 32: 7S50ME-C – 75% load

ME Engine Programme



L73846-6.1/0303

(2440/PCS)



Fig. 33: ME Engine Programme